

SMALL SIGNAL SCHOTTKY DIODE

FEATURES AND BENEFITS

- VERY SMALL CONDUCTION LOSSES
- NEGLIGIBLE SWITCHING LOSSES
- LOW FORWARD VOLTAGE DROP
- LOW THERMAL RESISTANCE
- EXTREMELY FAST SWITCHING
- SURFACE MOUNTED DEVICE

DESCRIPTION

Low turn-on and high breakdown voltage diodes intended for

ultrafast switching and UHF detectors in hybrid micro circuits. Packaged in SOT-143, this device is intended for surface mounting. Its dual independent diodes configuration makes it very interesting for applications where high integration is searched.

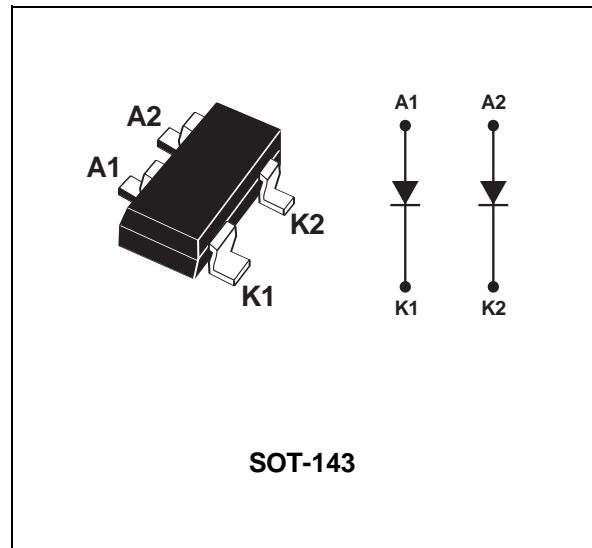

ABSOLUTE RATINGS (limiting values)

Symbol	Parameter		Value	Unit
V _{RRM}	Repetitive peak reverse voltage		70	V
I _F	Continuous forward current		15	mA
I _{FSM}	Surge non repetitive forward current	tp = 10ms	1	A
P _{tot}	Power Dissipation (note 1)	T _{amb} = 25°C	310	mW
T _{stg}	Storage temperature range		- 65 to +150	°C
T _j	Maximum operating junction temperature *		150	°C
TL	Maximum temperature for soldering during 10s		260	°C

Note 1: P_{tot} is the total dissipation of both diodes.

$$* : \frac{dP_{tot}}{dT_j} < \frac{1}{R_{th(j-a)}} \text{ thermal runaway condition for a diode on its own heatsink}$$

THERMAL RESISTANCE

Symbol	Parameter	Value	Unit
R _{th(j-a)}	Junction to ambient (*)	400	°C/W

(*) Mounted on epoxy board with recommended pad layout.

BAS70-07

STATIC ELECTRICAL CHARACTERISTICS

Symbol	Tests Conditions	Tests Conditions	Min.	Typ.	Max.	Unit	
V_F^*	Forward voltage drop	$T_j = 25^\circ\text{C}$	$I_F = 1\text{ mA}$			410	mV
			$I_F = 10\text{ mA}$			750	mV
			$I_F = 15\text{ mA}$			1	V
V_{BR}	Breakdown voltage	$T_j = 25^\circ\text{C}$	$I_R = 10\ \mu\text{A}$	70		V	
I_R^{**}	Reverse leakage current	$T_j = 25^\circ\text{C}$	$V_R = 50\text{ V}$			200	nA
			$V_R = 70\text{ V}$			10	μA

Pulse test: * $t_p = 380\ \mu\text{s}$, $\delta < 2\%$

** $t_p = 5\text{ ms}$, $\delta < 2\%$

DYNAMIC CHARACTERISTICS ($T_j = 25^\circ\text{C}$)

Symbol	Parameters	Tests Conditions	Min.	Typ.	Max.	Unit
C	Junction capacitance	$V_R = 1\text{ V}$ $F = 1\text{ MHz}$			2	pF
t_{rr}	Reverse recovery time	$I_F = 10\text{ mA}$ $I_{rr} = 1\text{ mA}$ $I_R = 10\text{ mA}$ $R_L = 100\ \Omega$			5	ns
τ	Effective carrier lifetime	$I_F = 5\text{ mA}$ Krakauer method			100	ps

Fig.1 : Average forward power dissipation versus average forward current.

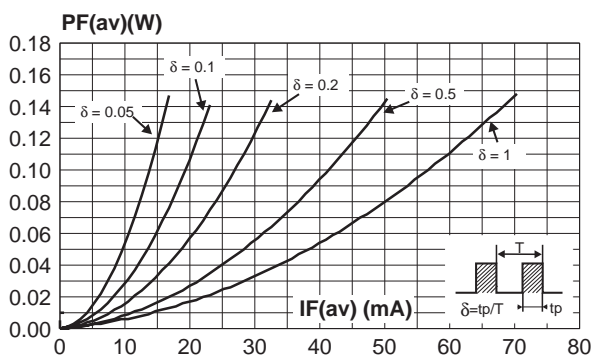

Fig.2 : Continuous forward current versus ambient temperature.

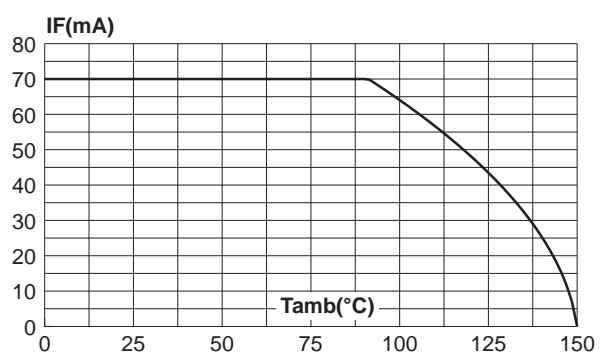

Fig.3 : Non repetitive surge peak forward current versus overload duration (maximum values).

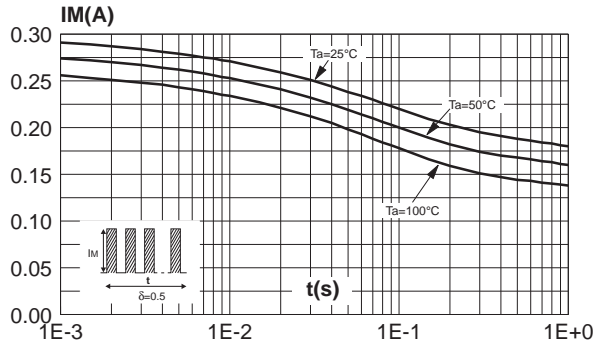

Fig.4 : Relative variation of thermal impedance junction to ambient versus pulse duration (alumine substrate 10mm x 8mm x 0.5mm).

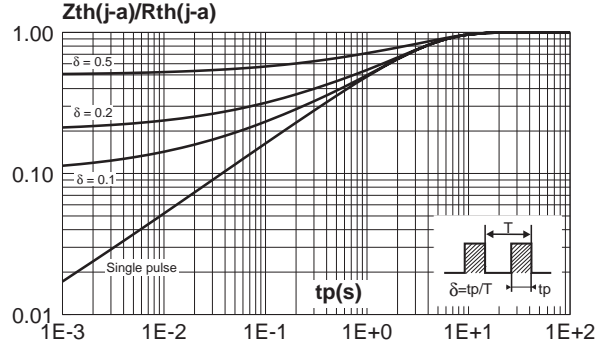

Fig.5 : Reverse leakage current versus reverse voltage applied (typical values).

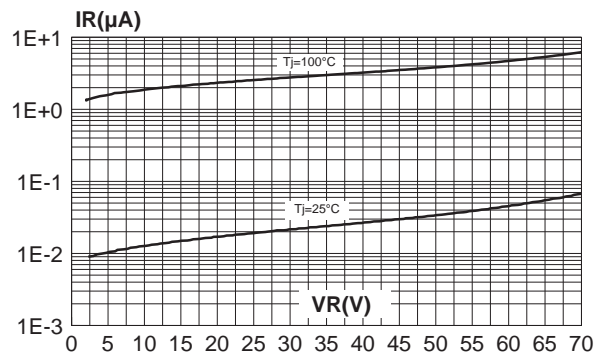

Fig.6 : Reverse leakage current versus junction temperature (typical values).

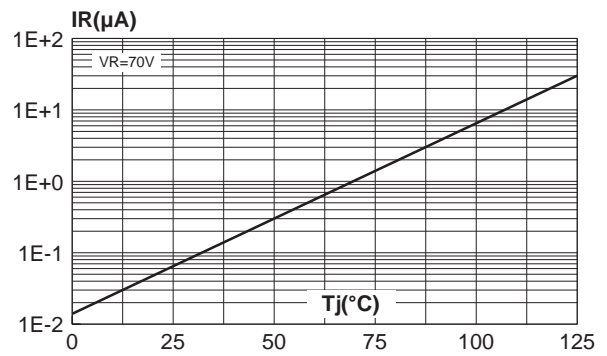

Fig.7 : Junction capacitance versus reverse voltage applied (typical values).

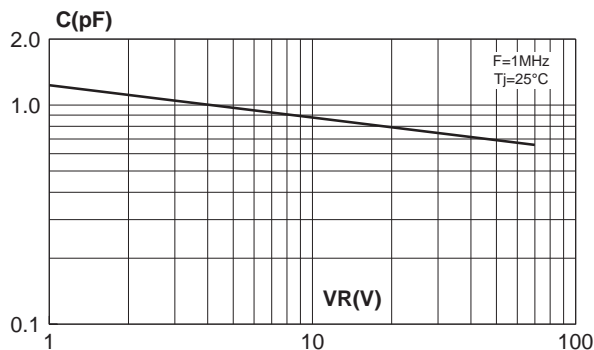
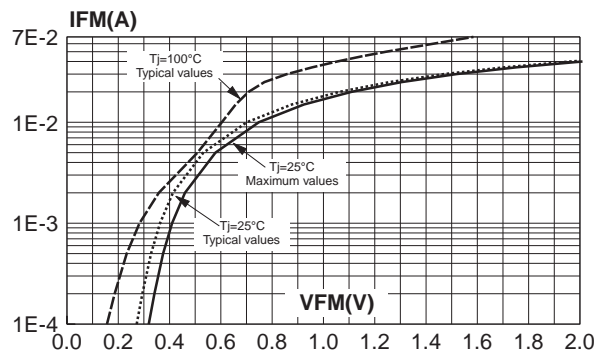

Fig.8 : Forward voltage drop versus forward current.



BAS70-07

PACKAGE MECHANICAL DATA SOT-143

REF.	DIMENSIONS			
	Millimeters		Inches	
	Min.	Max.	Min.	Max.
A	0.8	1.2	0.0314	0.0472
A1	0.01	0.127	0.0004	0.005
b	0.35	0.6	0.014	0.024
b1	0.55	0.95	0.022	0.037
C	0.085	0.2	0.003	0.008
D	2.8	3.04	0.11	0.12
E	1.2	1.4	0.047	0.055
e1	1.90 Typ.		0.075 Typ.	
e2	0.2 Typ.		0.008 Typ.	
H	2.1	2.64	0.083	0.103
L	0.55 Typ.		0.022 Typ.	

FOOTPRINT DIMENSIONS (millimeters)

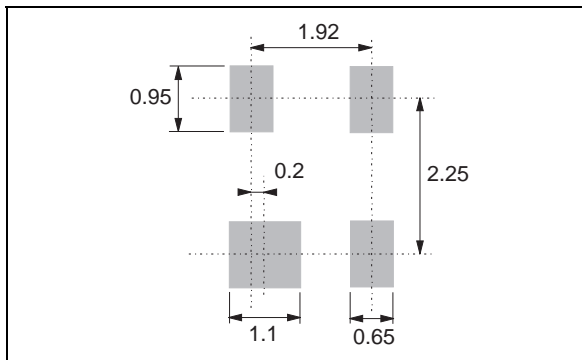

MARKING

Type	Marking	Package	Weight	Base qty	Delivery mode
BAS70-07	D99	SOT-143	0.01g.	3000	Tape & reel

Information furnished is believed to be accurate and reliable. However, STMicroelectronics assumes no responsibility for the consequences of use of such information nor for any infringement of patents or other rights of third parties which may result from its use. No license is granted by implication or otherwise under any patent or patent rights of STMicroelectronics. Specifications mentioned in this publication are subject to change without notice. This publication supersedes and replaces all information previously supplied. STMicroelectronics products are not authorized for use as critical components in life support devices or systems without express written approval of STMicroelectronics.

The ST logo is a registered trademark of STMicroelectronics

© 1999 STMicroelectronics - Printed in Italy - All rights reserved.

STMicroelectronics GROUP OF COMPANIES

Australia - Brazil - China - Finland - France - Germany - Hong Kong - India - Italy - Japan - Malaysia
Malta - Morocco - Singapore - Spain - Sweden - Switzerland - United Kingdom - U.S.A.

<http://www.st.com>